

Lenz Digitalzentrale (2-Leiter Gleis): DigitalBooster DB-2 über Adapter Adap-CDE anschließen Lenz command station (2-rail conductor): Connecting the DigitalBooster DB-2 via Adapter Adap-CDE

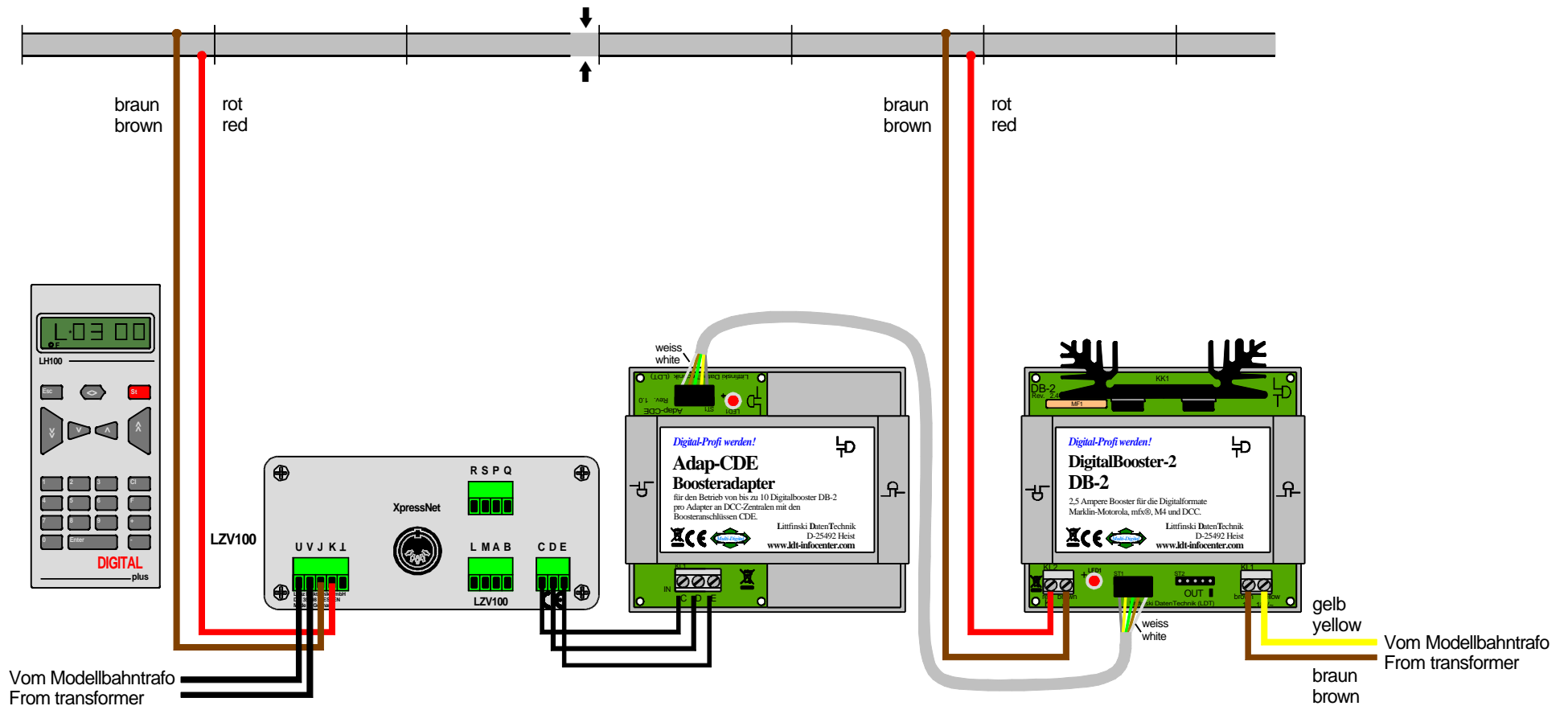

Technische Änderungen und Irrtum vorbehalten.
 Subject to technical changes and errors.
 © 06/2013 by LDT

