

EasyControl (2-Leiter Gleis): DigitalBooster DB-2 über 5-poligen Boosterbus anschließen

EasyControl (2-rail conductor): Connecting the DigitalBooster DB-2 via 5-poles booster bus

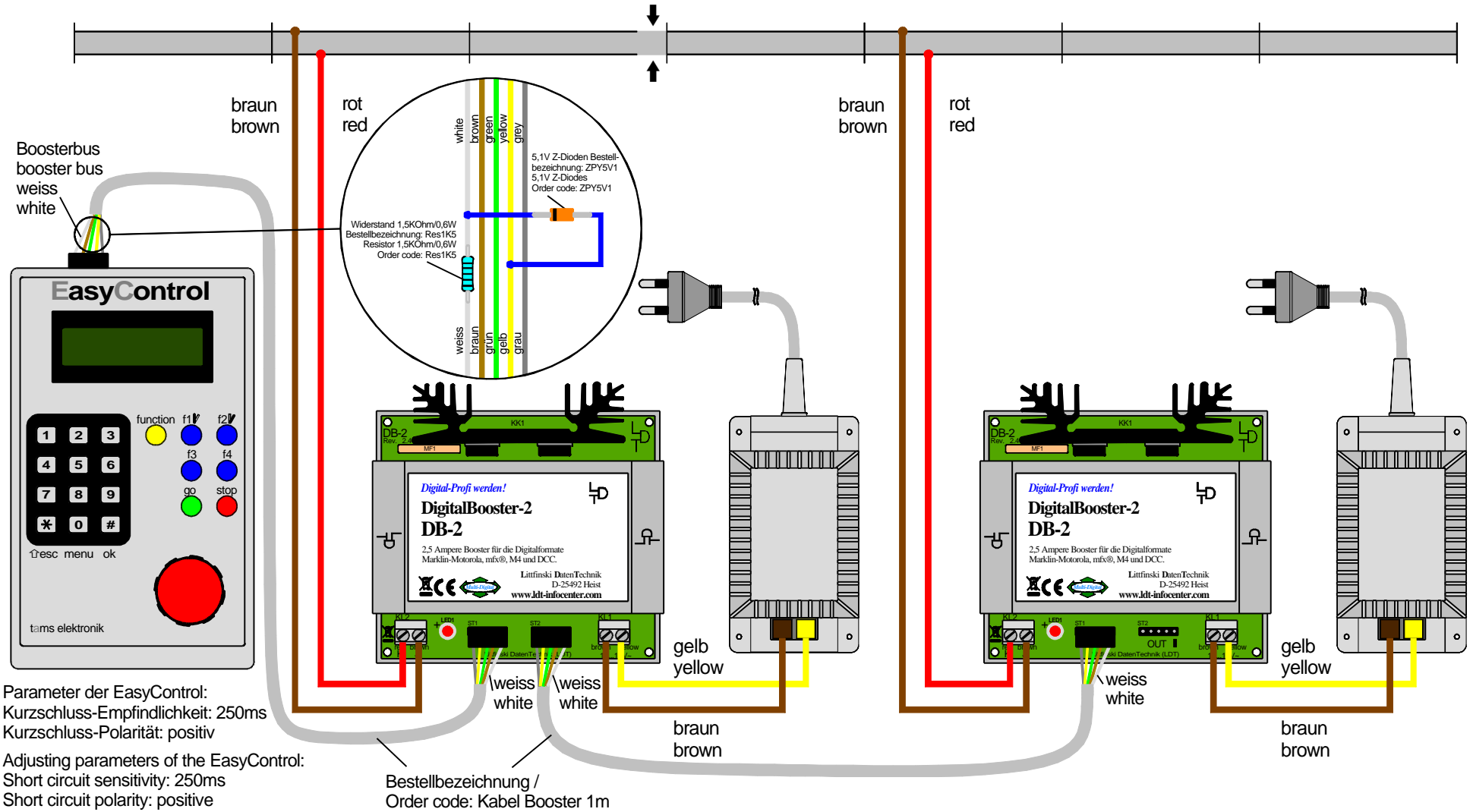

Technische Änderungen und Irrtum vorbehalten.
Subject to technical changes and errors.
© 07/2014 by LDT